



**CHEVROLET CORVETTE STINGRAY
AUSSTATTUNG & PREISE**

MODELLJAHR 2022



CHEVROLET CORVETTE STINGRAY

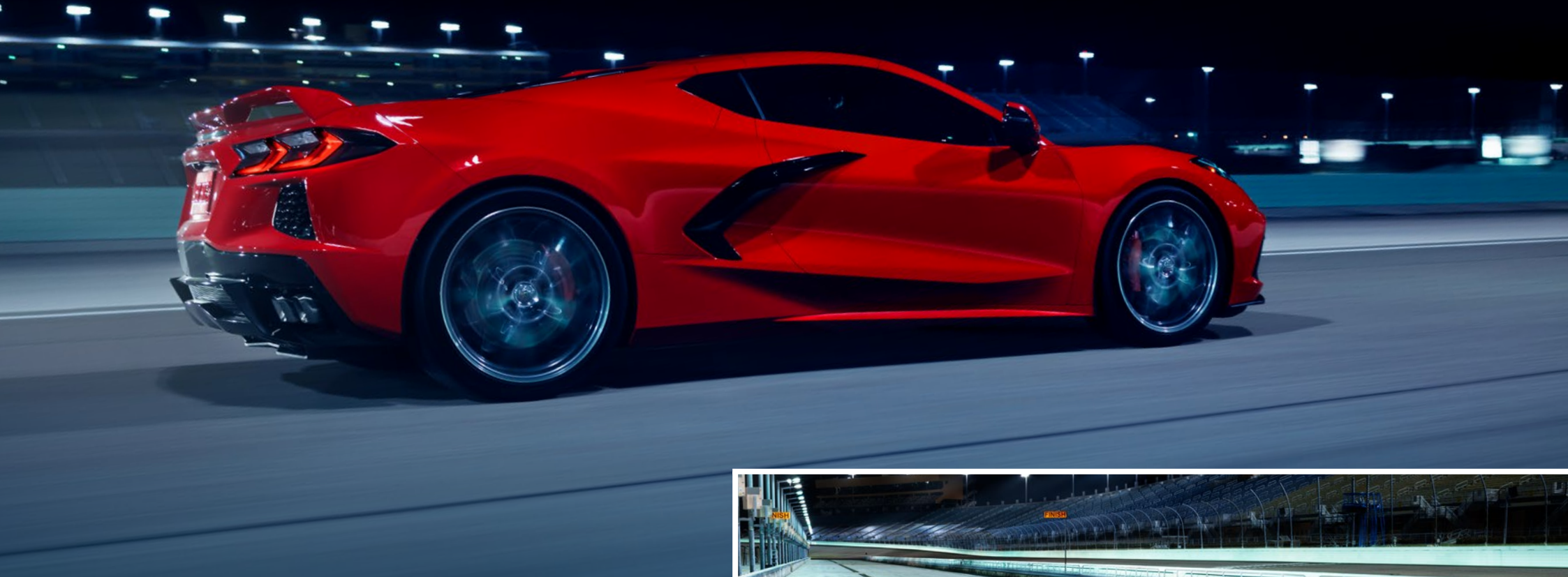

CHEVROLET CORVETTE STINGRAY



Z51 - PERFORMANCE-PAKET

DER GIPFEL DER LEISTUNG

Die Architektur, Struktur, Radaufhängung, Kalibrierungen und Software der Stingray bieten ein Fahrerlebnis, das Ihre Vorstellungskraft übersteigt. Um die Leistung bis zum Höhepunkt zu steigern, sind alle europäischen Corvette Stingrays serienmäßig mit dem Z51 Performance-Paket ausgestattet, das eine Reihe von Leistungsverbesserungen bietet, darunter:

- Z51-Performance-Fahrwerk
- Z51-Performance-Brembo®-Bremsen
- Michelin® Pilot® Sport 4S, 245/35ZR19 vorn und 305/30ZR20 hinten, Hochleistungs-Notlauf-Sommerreifen¹
- Elektronisch geregeltes Sperrdifferential (eLSD)
- Performance-Auspuff
- Performance-Hinterachsübersetzung
- Hochleistungskühlsystem
- Z51-Heckspoiler in Karosseriefarbe
- Z51-Frontsplitter



¹ Verwenden Sie Sommerreifen nicht bei winterlichen Witterungsverhältnissen. Dies würde sich negativ auf die Sicherheit, Performance und Lebensdauer des Fahrzeugs auswirken. Nutzen Sie ausschließlich von GM genehmigte Kombinationen für Reifen und Felgen. Nicht genehmigte Kombinationen können sich auf das Leistungsverhalten des Fahrzeugs auswirken. Wichtige Informationen zu Reifen und Felgen erhalten Sie bei Ihrem Chevrolet-Partner. Bei Reifen mit niedrigem Querschnitt kommt es schneller zu Reifenabrieb und unwegsame oder beschädigte Fahrbahnen sowie Bordsteine, Schutt und Hindernisse können zu Beschädigungen führen. Diese Beschädigungen werden nicht von GMS beschränkter Garantie für Neuwagen abgedeckt.

PREISE

	PREIS ¹	MWST. 19%	KUNDENNETTOPREIS (OHNE MWST.)
Corvette Stingray Coupé 2LT	86'900 €	13'875 €	73'025 €
Corvette Stingray Coupé 3LT	90'550 €	14'458 €	76'092 €
Corvette Stingray Cabriolet 2LT	93'400 €	14'913 €	78'487 €
Corvette Stingray Cabriolet 3LT	97'050 €	15'495 €	81'555 €

Chevrolet Corvette Stingray 6.2L V8 - Kraftstoffverbrauch, innerorts (l/100 km): 24.3*, außerorts (l/100 km): 9.6*, kombiniert (l/100 km): 12.1*. CO₂-Emissionen, kombiniert (g/km): 277. CO₂-Effizienzklasse: G.

* Die gem. der noch in der bisherigen Form geltenden PKW-EnVKV anzugebenden Kraftstoffverbrauchs- und CO₂-Emissionswerte nach dem sog. «neuen europäischen -Fahrzyklus» (NEFZ) sind nicht mehr verfügbar, da dieser seit dem 01.09.2018 durch das weltweit harmonisierte Prüfverfahren WLTP ersetzt wurde. Wir geben für die Fahrzyklen «innerorts» und «außerorts» daher nicht die NEFZ-, sondern die WLTP-Werte an. Eine exakte Vergleichbarkeit mit den nach dem bisherigen NEFZ-Testzyklus gemessenen Werten ist nicht möglich. «Niedrig» entspricht aber in etwa dem «innerorts»-Teil und «Hoch» dem «außerorts»-Teil der alten NEFZ-Werte.

MOTOR

CORVETTE STINGRAY

Motor	6,2 L V8-Benzinmotor mit Direkteinspritzung, variabler Ventilsteuerung und Active Fuel Management (Zylinderabschaltungstechnologie)
Getriebe	8-Gang-Doppelkupplungsgetriebe
Erforderlicher Kraftstoff	Benzin
Hubraum	6162 cc
Bohrung	103.25 mm
Hub	92.0 mm
Kompressionsrate	11.5 : 1
Leistung	354 kW/482 PS bei 6450 Umdrehungen pro Min
Drehmoment	613 Nm bei 4500 Umdrehungen pro Min
Höchstgeschwindigkeit	296 km/h
Beschleunigung 0 - 100 km/h	3.5 Sek
Ventiltrieb	Obenliegend, zwei Ventile pro Zylinder; Dual Equal variable Ventilsteuerung
Ölsystem	Trockensumpfschmierung mit Spritzdüsen-Ölkühlung des Kolben

KRAFTSTOFFVERBRAUCH UND CO₂-EMISSIONEN²

CORVETTE STINGRAY

Abgasnorm	Euro 6d
CO ₂ -Effizienzklasse	G
Kraftstoffverbrauch, innerorts	24.3 l/100 km
Kraftstoffverbrauch, außerorts	9.6 l/100 km
Kraftstoffverbrauch, kombiniert	12.1 l/100 km
CO ₂ -Emissionen, kombiniert	277 g/km

¹ Alle Preisangaben dieser Preisliste sind unverbindliche Preisempfehlungen für Modelljahr 2022 inklusive 19% MwSt., zzgl. Überführungskosten.

² Die aufgeführten WLTP-Werte wurden nach dem weltweit harmonisierte Prüfverfahren für Personenwagen und leichte Nutzfahrzeuge (Worldwide Harmonized Light Vehicles Test Procedure, WLTP), gemäß der Verordnung (EG) Nr. 715/2007 in der für die Typgenehmigung des betreffenden Fahrzeugmodells gültigen Version, ermittelt. Die angegebenen Werte dienen allein Vergleichszwecken. Vergleichen Sie die Verbrauchs- und CO₂-Werte nur mit Fahrzeugen, die nach denselben technischen Verfahren getestet wurden. Je nach eingebauten Zubehör (nach der Zulassung), Wetterbedingungen, Fahrstil und Zuladung können sich in der Praxis Werte ergeben, die von den angegebenen Werten abweichen. Die Angaben beziehen sich nicht auf ein einzelnes Fahrzeug und sind nicht Bestandteil des Angebots. Weitere Informationen zum offiziellen Kraftstoffverbrauch und den offiziellen spezifischen CO₂-Emissionen neuer Personenkraftwagen können dem Leitfaden über den Kraftstoffverbrauch und die CO₂-Emissionen neuer Personenkraftwagen entnommen werden, der an allen Verkaufsstellen, bei der DAT Deutsche Automobil Treuhand GmbH, Helmuth-Hirth-Straße 1, D-73760 Ostfildern oder online unter www.dat.de unentgeltlich erhältlich ist.

• Serienmäßig ○ Verfügbar – Nicht verfügbar

FAHRWERK & FEDERUNG	CODE	CORVETTE STINGRAY
Antriebsachse		Heckantrieb
Lenkung		Regelbare Zahnstange mit elektrischer Servounterstützung; enthält Active Steer Stops mit optionalem Magnetic Selective Ride Control
Radaufhängung		Trapez Doppelquerlenker, obere Querlenker aus geschmiedetem Aluminium und untere Querlenker in L-Form aus Aluminiumguss; Einrohr-Stoßdämpfer (46 mm)
Bremsen		E-Boost-unterstützte Scheibenbremsen vorn und hinten mit Vierkolben-Monoblock-Bremssätteln von Brembo
Launch Control		•
Driver Mode Selector		•
Aktive Fahrstabilitätskontrolle mit Traktionskontrolle		•
Magnetic Selective Ride Control™ Dämpfungssystem mit Performance Traction Management	FE4	2'400 €

AUSSTATTUNG	CODE	COUPÉ		CABRIOLET	
		2LT	3LT	2LT	3LT
KOMFORT					
Zwei-Zonen-Klimaautomatik mit individuellen Einstellungen für Fahrer und Beifahrer		•	•	•	•
Luftfiltersystem mit Pollenfilter		•	•	•	•
Elektrisch verstellbare Lenksäule (Höhe und Länge)		•	•	•	•
Automatisch beheizbares Lenkrad ³		•	•	•	•
Schaltwippen am Lenkrad		•	•	•	•
Lenkradsteuerung für Audio, Telefon, Geschwindigkeitsregelung und Fahrerinformationssystem		•	•	•	•
Memory-Paket - Lenkrad-, Außenspiegel- und Sitzmemory für Fahrer und Beifahrer		•	•	•	•
Rückspiegelkamera		•	•	•	•
HD-Front- und -Rückfahrkameras, Frontkamera mit Bordsteinsicht		•	•	•	•
Ultraschall-Einparkhilfe hinten ³		•	•	•	•
Front lift mit Memory-Funktion ⁴	E60	1'950 €	1'950 €	1'950 €	1'950 €
Geschwindigkeitsregelanlage		•	•	•	•
Head-up-Farbdisplay, konfigurierbar		•	•	•	•
Elektrische Fensterheber mit Express-Auf und -Ab für Fahrer und Beifahrer		•	•	•	•
Scheinwerfer mit automatischer An- und Abschaltung und Tunnelerkennung		•	•	•	•
Automatische Scheinwerfer-Höhenverstellung		•	•	•	•
Performance Data Recorder ^{3,5}		•	•	•	•
Schlüsselloser Einstieg und Startknopf		•	•	•	•
Universal Home Remote, inklusive Garagentorsteuerung, programmierbar		•	•	•	•
Valet Mode		•	•	•	•
Batterieschutzpaket ⁶	ERI	100 €	100 €	100 €	100 €
Gepäcknetze		•	•	•	•

³ Die Verfügbarkeit dieser Ausstattung kann eingeschränkt und erst zu einem späteren Zeitpunkt gegeben sein.

⁴ Der Front Lift hebt die Fahrzeugfront bei niedrigeren Geschwindigkeiten (bis zu 35 – 40 km/h) in weniger als 3 Sekunden um ca. 50 mm an und speichert bis zu 1'000 GPS-Positionen.

⁵ Bei der Nutzung des PDR-Systems sind datenschutzrechtliche und andere gesetzliche Vorgaben durch den Fahrer zu beachten, die insbesondere eine Benutzung des PDR-Systems auf öffentlichen Straßen unter Umständen einschränken oder ausschließen können.

⁶ Enthält ein Gerät zum Laden und Konditionieren der Fahrzeugbatterie, das dazu beiträgt, die optimale Funktionalität bei längerem Parken zu erhalten.

• Serienmäßig ○ Verfügbar – Nicht verfügbar

AUSSTATTUNG

CODE

COUPÉ

CABRIOLET

2LT

3LT

2LT

3LT

SITZKOMFORT

GT1-Schalensitze		•	-	•	-
GT2-Schalensitze	AH2	2'200 €	•	2'200 €	•
Competition Sport-Schalensitze	AE4	3'200 €	1'000 €	3'200 €	1'000 €
Fahrer- und Beifahrersitze beheizbar und belüftet ⁷		•	•	•	•
8-fach elektrisch verstellbarer Fahrersitz		•	•	•	•
8-fach elektrisch verstellbarer Beifahrersitz		•	•	•	•
Fahrersitz mit 2-fach elektrisch verstellbarer Lendenwirbelstütze		•	•	•	•
Beifahrersitz mit 2-fach elektrisch verstellbarer Lendenwirbelstütze		•	•	•	•
Fahrersitz mit elektrisch verstellbaren seitlichen Lehnenpolstern		•	•	•	•
Beifahrersitz mit elektrisch verstellbaren seitlichen Lehnenpolstern		•	•	•	•
Zweifarbige Sitze	TU7	400 €	400 €	400 €	400 €

AUDIO UND KOMMUNIKATION

Fahrerinformationssystem mit konfigurierbarem, hochauflösendem 12-Zoll-Farbdisplay		•	•	•	•
Chevrolet Infotainment Premium-System mit Navigation, 8-Zoll-HD-Farb-Touchscreen, Spracherkennung, USB-Anschlüssen, zusätzlichem Audioanschluß und SD-Kartenleser ⁸		•	•	•	•
Bose® Performance Series Soundsystem mit 14 Lautsprechern und aktiver Geräuschunterdrückungstechnologie		•	•	•	•
DAB/DAB+/DMB-R (Digital Audio Broadcast)		•	•	•	•
Kabellose Ladestation für Mobiltelefone ⁹		•	•	•	•
Smartphone-Integration via Apple CarPlay™ und Android Auto™ ¹⁰		•	•	•	•
Nahfeldkommunikation (NFC)		•	•	•	•

SICHERHEIT

Toter-Winkel-Assistent		•	•	•	•
Querverkehrswarnung hinten		•	•	•	•
Diebstahlschutzsystem gegen unbefugten Zutritt		•	•	•	•
Diebstahlschutzsensor, Karosseriesicherheit		•	•	•	•
Diebstahlschutzsensor, Fahrzeugneigung		•	•	•	•
Diebstahlschutzsensor, Bewegung im Fahrzeuginnenraum		•	•	•	•
Diebstahlwarnsystem mit eigener Stromversorgung		•	•	•	•
Lenkradschloss		•	•	•	•
Airbags: für Fahrer und Beifahrer, Frontal- und Seitenaufprall mit Passenger Sensing System		•	•	•	•
Automatischer Notruf		•	•	•	•

⁷ Die Verfügbarkeit dieser Ausstattung kann eingeschränkt und erst zu einem späteren Zeitpunkt gegeben sein.

⁸ Spracherkennung ist für die folgenden Sprachen erhältlich: Englisch, Französisch, Deutsch, Niederländisch, Italienisch, Polnisch, Dänisch, Portugiesisch, Spanisch, Türkisch und Russisch.

¹⁰ Das System kann ein PMA- oder Qi-kompatibles Mobiltelefon induktiv laden. Zur Nutzung dieser Funktion muss das Mobiltelefon induktives Laden unterstützen. ⁹ Bei den Benutzeroberflächen im Fahrzeug handelt es sich um Produkte von Apple und Google und daher gelten deren Geschäftsbedingungen und Datenschutzerklärungen. Ein kompatibles Smartphone ist erforderlich und es fallen Kosten eines Datentarifs an. Android Auto™ erfordert ein Smartphone mit dem Betriebssystem Android Lollipop 5.0 oder höher; für Apple CarPlay™ wird ein iPhone 5 oder höher benötigt. Eine vollständige Auflistung der unterstützten Apps finden Sie unter Apple.com/ios/carplay und Android.com/auto. Bitte beachten Sie, dass die Verfügbarkeit der Apps je nach Markt variieren kann.

• Serienmäßig ○ Verfügbar - Nicht verfügbar

AUSSTATTUNG

CODE

COUPÉ

CABRIOLET

2LT

3LT

2LT

3LT

AUßENAUSSTATTUNG

Beheizbare, elektrisch verstell- und einklappbare, auf der Fahrerseite automatisch abblendende Außenspiegel in Wagenfarbe, mit integrierten Blinkern		•	•	•	•
Signatur-LED-Scheinwerfer mit Tagfahrlicht		•	•	•	•
Nebelschlussleuchten		•	•	•	•
Solar-Ray® getöntes Glas		•	•	•	•
Heckklappenentriegelung mit Druckknopf		•	•	-	-
Kofferraumentriegelung mit Druckknopf		-	-	•	•
Auspuffendrohr, poliert		•	•	•	•
Tanksystem ohne Tankdeckel		•	•	•	•
Carbon Flash Farbakzentpaket – Heckspoiler und Außenspiegel	ZYC	1'500 €	1'500 €	1'500 €	1'500 €
Äußere Zierelemente in Carbon Flash – seitliche Einlässe, vorderer/hinterer Kühlergrill (und Tonneau Grille beim Cabriolet)		•	•	•	•
Äußere Zierelemente in Wagenfarbe – seitliche Einlässe, vorderer/hinterer Kühlergrill (und Tonneau Grille beim Cabriolet) ¹¹	EFY	500 €	500 €	500 €	500 €
Äußere Zierelemente in Shadow Gray – seitliche Einlässe, vorderer/hinterer Kühlergrill (und Tonneau Grille beim Cabriolet)	EFA	500 €	500 €	500 €	500 €
Corvette-Emblem außen in Carbon Flash		•	•	•	•
Corvette-Emblem außen in Chrom	EYK	300 €	300 €	300 €	300 €
Dachpanel in Wagenfarbe ¹²		•	•	-	-
Transparentes Dachpanel ¹²	CC3	950 €	950 €	-	-
Dachpanel mit sichtbaren Karbonfasern und Einfassung in Wagenfarbe ¹²	C2Z	1'850 €	1'850 €	-	-
Paket mit zwei Dachpanels: eines in Wagenfarbe, eines transparent ¹²	C2Q	1'850 €	1'850 €	-	-
Paket mit zwei Dachpanels: eines transparent, eines mit sichtbaren Karbonfasern und Einfassung in Wagenfarbe ¹²	C2M	2'800 €	2'800 €	-	-

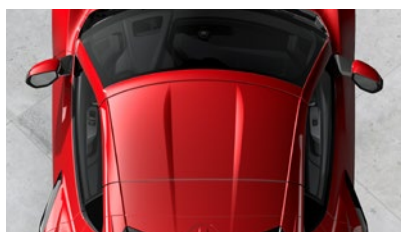

Dachpanel in Wagenfarbe (serienmäßig)



Transparentes Dachpanel (CC3)



Dachpanel mit sichtbaren Karbonfasern und Einfassung in Wagenfarbe (C2Z)

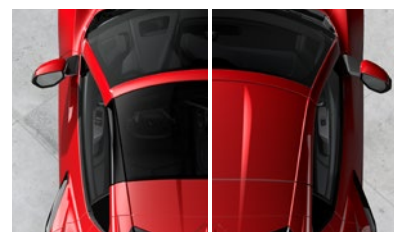

Paket mit zwei Dachpanels: eines in Wagenfarbe, eines transparent (C2Q)



Paket mit zwei Dachpanels: eines transparent, eines mit sichtbaren Karbonfasern und Einfassung in Wagenfarbe (C2M)

¹¹ Mit Außenfarbe Black nicht erhältlich.
¹² Abnehmbar, lässt sich sicher im Kofferraum verstauen.
 • Serienmäßig ○ Verfügbar – Nicht verfügbar

AUSSTATTUNG	CODE	COUPÉ		CABRIOLET	
		2LT	3LT	2LT	3LT
Elektrisch versenkbares Cabrio-Hardtop ¹³		-	-	•	•
Hinterere Dachelemente in Carbon Flash und Dach in Wagenfarbe ¹⁴	D86	-	-	600 €	600 €
Hinterere Dachelemente und Dach in Carbon Flash ¹⁴	D84	-	-	1'500 €	1'500 €



serienmäßig



Hinterere Dachelemente in Carbon Flash und Dach in Wagenfarbe (D86)



Hinterere Dachelemente und Dach in Carbon Flash (D84)

Aluminiumfelgen mit 5 offenen Speichen und Bright Silver Finish: vorn 19 X 8,5 J und hinten 20 X 11,0 J		•	•	•	•
Aluminiumfelgen mit 5 offenen Speichen, geschliffenen Kanten und Carbon Flash Finish: vorn 19 X 8,5 J und hinten 20 X 11,0 J	Q8Q	950 €	950 €	950 €	950 €
Aluminiumfelgen mit 5-Dreizack-Speichen, geschliffenen Stirnflächen und Sterling Silver Finish: vorn 19 X 8,5 J und hinten 20 X 11,0 J	Q8S	1'450 €	1'450 €	1'450 €	1'450 €
Aluminiumfelgen mit 5-Dreizack-Speichen, geschliffenen Stirnflächen und Spectra Gray Finish: vorn 19 X 8,5 J und hinten 20 X 11,0 J	Q8T	1'450 €	1'450 €	1'450 €	1'450 €



Aluminiumfelgen mit 5 offenen Speichen und Bright Silver Finish: vorn 19 X 8,5 J und hinten 20 X 11,0 J (serienmäßig)



Aluminiumfelgen mit 5 offenen Speichen, geschliffenen Kanten und Carbon Flash Finish: vorn 19 X 8,5 J und hinten 20 X 11,0 J (Q8Q)



Aluminiumfelgen mit 5-Dreizack-Speichen, geschliffenen Stirnflächen und Sterling Silver Finish: vorn 19 X 8,5 J und hinten 20 X 11,0 J (Q8S)



Aluminiumfelgen mit 5-Dreizack-Speichen, geschliffenen Stirnflächen und Spectra Gray Finish: vorn 19 X 8,5 J und hinten 20 X 11,0 J (Q8T)

Black lackierte Bremssättel		•	•	•	•
Bright Red lackierte Bremssättel	J6F	600 €	600 €	600 €	600 €
Edge Red lackierte Bremssättel	J6N	600 €	600 €	600 €	600 €
Edge Yellow lackierte Bremssättel	J6E	600 €	600 €	600 €	600 €



Black lackierte Bremssättel (serienmäßig)



Bright Red lackierte Bremssättel (J6F)



Edge Red lackierte Bremssättel (J6N)



Edge Yellow lackierte Bremssättel (J6E)

¹³ Das Cabrio-Hardtop kann während der Fahrt bei einer Geschwindigkeit von bis zu 50 km/h geöffnet oder geschlossen werden. Betätigung mit Knopfdruck (auf oder zu) oder aus der Ferne über den Fahrzeugschlüssel (nur auf). ¹⁴ Mit Außenfarbe Black nicht erhältlich.

• Serienmäßig ○ Verfügbar – Nicht verfügbar

AUSSTATTUNG	CODE	COUPÉ		CABRIOLET	
		2LT	3LT	2LT	3LT
		Doppelrennstreifen in Carbon Flash über die gesamte Länge	DTH	800 €	800 €
Doppelrennstreifen in Midnight Gray über die gesamte Länge	DX0	800 €	800 €	800 €	800 €
Doppelrennstreifen in Sterling Silver über die gesamte Länge	DUB	800 €	800 €	800 €	800 €
Doppelrennstreifen in Edge Red über die gesamte Länge ¹⁵	DSZ	800 €	800 €	800 €	800 €
Doppelrennstreifen in Edge Yellow über die gesamte Länge ¹⁶	DT0	800 €	800 €	800 €	800 €
Doppelrennstreifen in Edge Orange über die gesamte Länge ¹⁷	DSY	800 €	800 €	800 €	800 €
Doppelrennstreifen in Edge Blue über die gesamte Länge ¹⁸	DUW	800 €	800 €	800 €	800 €
Haubenstreifen in Midnight Silver/Carbon Flash	DZV	400 €	400 €	400 €	400 €
Haubenstreifen in Edge Red/Carbon Flash ¹⁵	DZX	400 €	400 €	400 €	400 €
Haubenstreifen in Edge Yellow/Carbon Flash ¹⁶	DZU	400 €	400 €	400 €	400 €



Doppelrennstreifen in Carbon Flash über die gesamte Länge (DTH)



Doppelrennstreifen in Midnight Gray über die gesamte Länge (DX0)



Doppelrennstreifen in Sterling Silver über die gesamte Länge (DUB)



Doppelrennstreifen in Edge Red über die gesamte Länge (DSZ)



Doppelrennstreifen in Edge Yellow über die gesamte Länge (DT0)



Doppelrennstreifen in Edge Orange über die gesamte Länge (DSY)



Doppelrennstreifen in Edge Blue über die gesamte Länge (DUW)



Haubenstreifen in Midnight Silver/Carbon Flash (DZV)



Haubenstreifen in Edge Red/Carbon Flash (DZX)



Haubenstreifen in Edge Yellow/Carbon Flash (DZU)

¹⁵ Mit Außenfarben Torch Red und Tactical Red Tintcoat nicht erhältlich.

¹⁶ Mit Außenfarbe Accelerate Yellow Metallic nicht erhältlich.

¹⁷ Mit Außenfarbe Amplify Orange Tintcoat nicht erhältlich.

¹⁸ Mit Außenfarben Elkhart Lake Blue Metallic und Rapid Blue nicht erhältlich.

• Serienmäßig ○ Verfügbar – Nicht verfügbar

AUSSTATTUNG

CODE

COUPÉ

CABRIOLET

2LT

3LT

2LT

3LT

INNENAUSSTATTUNG

Lederlenkrad, oben und unten abgeflacht		•	•	•	•
Lenkrad mit Mikrofaser-Veloursbezug, oben und unten abgeflacht		○	○	○	○
Interieur-Paket mit Lederbezug – oberes Armaturenbrett, Türverkleidungen und Konsolenabdeckung		-	•	-	•
Obere Innenausstattung mit Mikrofaser-Veloursbezug – Verkleidung Dachhimmel, Sonnenblenden und A-Säulen		-	•	-	•
Ziernähte in Adrenaline Red ¹⁹	38S	-	800 €	-	800 €
Ziernähte in Yellow ¹⁹	36S	-	800 €	-	800 €
Innenverkleidung mit Zierelementen aus Karbonfaser – Einfassung des Kombiinstrumentes und der Schalttafeln an der Konsole und den Türen	FA5	1'500 €	1'500 €	1'500 €	1'500 €
Teppich-Fußmatten		•	•	•	•
Stromanschlüße		•	•	•	•
Sicherheitsgurte in Black	719	0 €	0 €	0 €	0 €
Sicherheitsgurte in Tan	3N9	400 €	400 €	400 €	400 €
Sicherheitsgurte in Torch Red	3F9	400 €	400 €	400 €	400 €
Sicherheitsgurte in Yellow	3M9	400 €	400 €	400 €	400 €
Sicherheitsgurte in Orange	379	400 €	400 €	400 €	400 €
Sicherheitsgurte in Tension Blue	3A9	400 €	400 €	400 €	400 €



Sicherheitsgurte in Black (719)

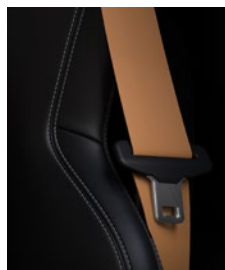

Sicherheitsgurte in Tan (3N9)

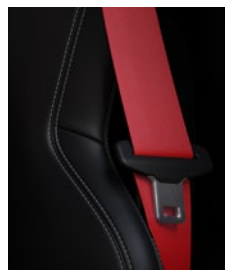

Sicherheitsgurte in Torch Red (3F9)

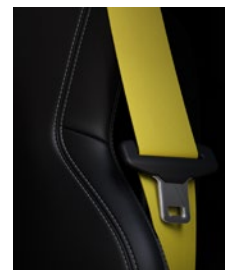

Sicherheitsgurte in Yellow (3M9)



Sicherheitsgurte in Orange (379)



Sicherheitsgurte in Tension Blue (3A9)

¹⁹ Nur mit Jet Black Innenausstattung. Zusätzlich Konsole und Türverkleidung aus Mikrofaser-Velours.

• Serienmäßig ○ Verfügbar – Nicht verfügbar

AUßENFARBEN	CODE	COUPÉ		CABRIOLET	
		2LT	3LT	2LT	3LT
		Black	GBA	0 €	0 €
Arctic White	G8G	0 €	0 €	0 €	0 €
Torch Red	GKZ	0 €	0 €	0 €	0 €
Flare Silver Metallic	GSJ	1'200 €	1'200 €	1'200 €	1'200 €
Hypersonic Gray Metallic	GA7	1'200 €	1'200 €	1'200 €	1'200 €
Caffeine Brown Metallic	G48	1'200 €	1'200 €	1'200 €	1'200 €
Accelerate Yellow Metallic	GDO	1'200 €	1'200 €	1'200 €	1'200 €
Elkhart Lake Blue Metallic	GS7	1'200 €	1'200 €	1'200 €	1'200 €
Rapid Blue	GM0	1'200 €	1'200 €	1'200 €	1'200 €
Ceramic Matrix Gray Metallic	G9F	1'200 €	1'200 €	1'200 €	1'200 €
Amplify Orange Tintcoat	GC5	2'200 €	2'200 €	2'200 €	2'200 €
Tactical Red Tintcoat	GPH	2'200 €	2'200 €	2'200 €	2'200 €



Black (GBA)



Arctic White (G8G)



Torch Red (GKZ)



Flare Silver Metallic (GSJ)



Hypersonic Gray Metallic (GA7)



Caffeine Brown Metallic (G48)



Accelerate Yellow Metallic (GDO)



Elkhart Lake Blue Metallic (GS7)



Rapid Blue (GM0)



Ceramic Matrix Gray Metallic (G9F)



Amplify Orange Tintcoat (GC5)



Tactical Red Tintcoat (GPH)

• Serienmäßig ○ Verfügbar – Nicht verfügbar

INNENFARBEN	CODE	COUPÉ		CABRIOLET	
		2LT	3LT	2LT	3LT
Mulan-Leder in Jet Black mit perforierten Ledersitzflächen	HTA	0 €	-	0 €	-
Mulan-Leder in Sky Cool Gray mit perforierten Ledersitzflächen	HUN	0 €	-	0 €	-
Mulan-Leder in Adrenaline Red mit perforierten Ledersitzflächen	HUR	0 €	-	0 €	-
Mulan-Leder in Natural mit perforierten Ledersitzflächen	HUV	0 €	-	0 €	-
Nappa-Leder in Jet Black mit perforierten Ledersitzflächen	HTM	0 €	-	0 €	-
Nappa-Leder in Jet Black mit Sitzflächen und Lenkrad in perforierter Velours-Mikrofaser	HTP	1'000 €	-	1'000 €	-
Nappa-Leder in Sky Cool Gray mit perforierten Ledersitzflächen	HUK	0	-	0	-
Nappa-Leder in Sky Cool Gray mit perforierten Ledersitzflächen (zweifarbige)	HUK+TU7	400 €	-	400 €	-
Nappa-Leder in Sky Cool Gray mit Sitzflächen und Lenkrad in perforierter Velours-Mikrofaser	HU6	1'000 €	-	1'000 €	-
Nappa-Leder in Sky Cool Gray mit Sitzflächen und Lenkrad in perforierter Velours-Mikrofaser (zweifarbige)	HU6+TU7	1'400 €	-	1'400 €	-
Nappa-Leder in Adrenaline Red mit perforierten Ledersitzflächen	HUL	0 €	-	0 €	-
Nappa-Leder in Adrenaline Red mit perforierten Ledersitzflächen (zweifarbige)	HUL+TU7	400 €	-	400 €	-
Nappa-Leder in Adrenaline Red mit Sitzflächen und Lenkrad in perforierter Velours-Mikrofaser	HU7	1'000 €	-	1'000 €	-
Nappa-Leder in Adrenaline Red mit Sitzflächen und Lenkrad in perforierter Velours-Mikrofaser (zweifarbige)	HU7+TU7	1'400 €	-	1'400 €	-
Nappa-Leder in Natural mit perforierten Ledersitzflächen	HTN	0 €	-	0 €	-
Nappa-Leder in Natural mit perforierten Ledersitzflächen (zweifarbige)	HTN+TU7	400 €	-	400 €	-
Nappa-Leder in Natural mit Sitzflächen und Lenkrad in perforierter Velours-Mikrofaser	HTQ	1'000 €	-	1'000 €	-
Nappa-Leder in Natural mit Sitzflächen und Lenkrad in perforierter Velours-Mikrofaser (zweifarbige)	HTQ+TU7	1'400 €	-	1'400 €	-
Nappa-Leder in Jet Black mit perforierten Ledersitzflächen	HTE	-	0 €	-	0 €
Nappa-Leder in Jet Black mit Sitzflächen und Lenkrad in perforierter Velours-Mikrofaser	HTT	-	1'000 €	-	1'000 €
Nappa-Leder in Sky Cool Gray mit perforierten Ledersitzflächen	HU1	-	0 €	-	0 €
Nappa-Leder in Sky Cool Gray mit perforierten Ledersitzflächen (zweifarbige)	HU1+TU7	-	400 €	-	400 €
Nappa-Leder in Sky Cool Gray mit Sitzflächen und Lenkrad in perforierter Velours-Mikrofaser	HU9	-	1'000 €	-	1'000 €
Nappa-Leder in Sky Cool Gray mit Sitzflächen und Lenkrad in perforierter Velours-Mikrofaser (zweifarbige)	HU9+TU7	-	1'400 €	-	1'400 €
Nappa-Leder in Adrenaline Red mit perforierten Ledersitzflächen	HU2	-	0 €	-	0 €
Nappa-Leder in Adrenaline Red mit perforierten Ledersitzflächen (zweifarbige)	HU2+TU7	-	400 €	-	400 €
Nappa-Leder in Adrenaline Red mit Sitzflächen und Lenkrad in perforierter Velours-Mikrofaser	HUA	-	1'000 €	-	1'000 €
Nappa-Leder in Adrenaline Red mit Sitzflächen und Lenkrad in perforierter Velours-Mikrofaser (zweifarbige)	HUA+TU7	-	1'400 €	-	1'400 €
Nappa-Leder in Natural mit perforierten Ledersitzflächen	HUE	-	0 €	-	0 €
Nappa-Leder in Natural mit perforierten Ledersitzflächen (zweifarbige)	HUE+TU7	-	400 €	-	400 €
Nappa-Leder in Natural mit Sitzflächen und Lenkrad in perforierter Velours-Mikrofaser	HTG	-	1'000 €	-	1'000 €
Nappa-Leder in Natural mit Sitzflächen und Lenkrad in perforierter Velours-Mikrofaser (zweifarbige)	HTG+TU7	-	1'400 €	-	1'400 €
Nappa-Leder in Natural Dipped mit perforierten Ledersitzflächen ²⁰	HZN	-	0 €	-	0 €
Nappa-Leder in Natural Dipped mit Sitzflächen und Lenkrad in perforierter Velours-Mikrofaser ²⁰	HUF	-	1'000 €	-	1'000 €
Nappa-Leder in Morello Red Dipped mit perforierten Ledersitzflächen ²¹	HU3	-	0 €	-	0 €
Nappa-Leder in Tension/Twilight Blue Dipped mit perforierten Ledersitzflächen ²²	HTO	-	0 €	-	0 €





²⁰ Vollfarbiges Interieur: Armaturenbrett, Türen, Teppich und Sicherheitsgurte in Natural. Konsole und Türverkleidung in Mikrofaser-Velours.

²¹ Vollfarbiges Interieur: Armaturenbrett, Türen, Teppich und Sicherheitsgurte in Morello Red. Konsole und Türverkleidung in Mikrofaser-Velours.

²² Vollfarbiges Interieur: Armaturenbrett, Türen und Teppich in Tension/Twilight Blue, Sicherheitsgurte in Tension Blue.

• Serienmäßig ○ Verfügbar – Nicht verfügbar

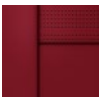
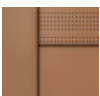
VERFÜGBARKEIT INNEN- / AUßENFARBEN

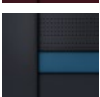
INNENFARBEN		AUßENFARBEN	Black (GBA)	Arctic White (G8G)	Torch Red (GKZ)	Flare Silver Metallic (GSJ)	Hypersonic Gray Metallic (GA7)	Caffeine Brown Metallic (G48)	Accelerate Yellow Metallic (GD0)	Elkhart Lake Blue Metallic (GS7)	Rapid Blue (GMO)	Ceramic Matrix Gray Metallic (G9F)	Amplify Orange Tintcoat (GC5)	Tactical Red Tintcoat (GPH)
	Jet Black		○	○	○	○	○	○	○	○	○	○	○	○
	Sky Cool Gray		○	○	○	○	○	○	○	○	○	○	○	○
	Adrenaline Red		○	○	○	○	○	-	-	-	-	○	-	-
	Natural		○	○	○	○	○	○	○	○	○	○	○	○
	Morello Red		○	○	-	○	○	-	-	-	-	○	-	○
	Tension/Twilight Blue		○	○	-	○	○	-	-	○	○	○	-	-

• Serienmäßig ○ Verfügbar - Nicht verfügbar

2LT INNENRÄUME



















GT1-SITZE A Q9

Mulan-Leder mit perforierten Ledersitzflächen

2LT LEDER VELOURS SITZGURTE AUßENFARBEN

JET BLACK



HTA	-	 Black (719, strd.)	 Tan (3N9)	 Torch Red (3F9)	 Black (GBA)	 Hypersonic Gray Metallic (GA7)	 Arctic White (G8G)	 Ceramic Matrix Gray Metallic (G9F)	 Flare Silver Metallic (GSJ)	 Accelerate Yellow Metallic (GDO)
0 €		 Yellow (3M9)	 Orange (379)	 Tension Blue (3A9)	 Amplify Orange Tintcoat (GC5)	 Torch Red (GKZ)	 Tactical Red Tintcoat (GPH)	 Caffeine Brown Metallic (G48)	 Rapid Blue (GMO)	 Elkhart Lake Blue Metallic (GS7)









SKY COOL GRAY



HUN	-	 Black (719, strd.)	 Torch Red (3F9)	 Black (GBA)	 Hypersonic Gray Metallic (GA7)	 Arctic White (G8G)	 Ceramic Matrix Gray Metallic (G9F)	 Flare Silver Metallic (GSJ)	 Accelerate Yellow Metallic (GDO)	
0 €		 Yellow (3M9)	 Orange (379)	 Tension Blue (3A9)	 Amplify Orange Tintcoat (GC5)	 Torch Red (GKZ)	 Tactical Red Tintcoat (GPH)	 Caffeine Brown Metallic (G48)	 Rapid Blue (GMO)	 Elkhart Lake Blue Metallic (GS7)

ADRENALINE RED



HUR	-	 Black (719, strd.)	 Torch Red (3F9)	 Black (GBA)	 Hypersonic Gray Metallic (GA7)	 Arctic White (G8G)	 Ceramic Matrix Gray Metallic (G9F)	 Flare Silver Metallic (GSJ)	 Torch Red (GKZ)
0 €									

NATURAL



HUV	-	 Black (719, strd.)	 Tan (3N9)	 Torch Red (3F9)	 Black (GBA)	 Hypersonic Gray Metallic (GA7)	 Arctic White (G8G)	 Ceramic Matrix Gray Metallic (G9F)	 Flare Silver Metallic (GSJ)	 Accelerate Yellow Metallic (GDO)
0 €		 Yellow (3M9)	 Orange (379)	 Tension Blue (3A9)	 Amplify Orange Tintcoat (GC5)	 Torch Red (GKZ)	 Tactical Red Tintcoat (GPH)	 Caffeine Brown Metallic (G48)	 Rapid Blue (GMO)	 Elkhart Lake Blue Metallic (GS7)

• Serienmäßig ○ Verfügbar - Nicht verfügbar

2LT INNENRÄUME

GT2-SITZE AH2

Nappa-Leder mit perforierten Ledersitzflächen /
Nappa-Leder mit Sitzflächen und Lenkrad in perforierter Velours-Mikrofaser

2LT

LEDER

VELOURS

SITZGURTE

AUßENFARBEN

JET BLACK



HTM

HTP

0 €

1'000 €



Black
(719, strd.)

Tan
(3N9)

Torch Red
(3F9)



Yellow
(3M9)

Orange
(379)

Tension Blue
(3A9)



Black (GBA)

Hypersonic Gray Metallic (GA7)

Arctic White (G8G)

Ceramic Matrix Gray Metallic (G9F)

Flare Silver Metallic (GSJ)

Accelerate Yellow Metallic (GDD)



Amplify Orange Tintcoat (GC5)

Torch Red (GKZ)

Tactical Red Tintcoat (GPH)

Caffeine Brown Metallic (G48)

Rapid Blue (GMO)

Elkhart Lake Blue Metallic (GS7)

SKY COOL GRAY



HUK

HU6

0 €

1'000 €



Black
(719, strd.)

Torch Red
(3F9)



Yellow
(3M9)

Orange
(379)

Tension Blue
(3A9)



Black (GBA)

Hypersonic Gray Metallic (GA7)

Arctic White (G8G)

Ceramic Matrix Gray Metallic (G9F)

Flare Silver Metallic (GSJ)

Accelerate Yellow Metallic (GDD)



Amplify Orange Tintcoat (GC5)

Torch Red (GKZ)

Tactical Red Tintcoat (GPH)

Caffeine Brown Metallic (G48)

Rapid Blue (GMO)

Elkhart Lake Blue Metallic (GS7)

ADRENALINE RED



HUL

-

0 €



Black
(719, strd.)

Torch Red
(3F9)



Black (GBA)

Hypersonic Gray Metallic (GA7)

Arctic White (G8G)

Ceramic Matrix Gray Metallic (G9F)

Flare Silver Metallic (GSJ)



Torch Red
(GKZ)

NATURAL



HTN

HTQ

0 €

1'000 €



Black
(719, strd.)

Tan
(3N9)

Torch Red
(3F9)



Yellow
(3M9)

Orange
(379)

Tension Blue
(3A9)



Black (GBA)

Hypersonic Gray Metallic (GA7)

Arctic White (G8G)

Ceramic Matrix Gray Metallic (G9F)

Flare Silver Metallic (GSJ)

Accelerate Yellow Metallic (GDD)



Amplify Orange Tintcoat (GC5)

Torch Red (GKZ)

Tactical Red Tintcoat (GPH)

Caffeine Brown Metallic (G48)

Rapid Blue (GMO)

Elkhart Lake Blue Metallic (GS7)

• Serienmäßig ○ Verfügbar - Nicht verfügbar

2LT INNENRÄUME

GT2-SITZE AH2+TU7 (ZWEIFARBIG)

Nappa-Leder mit perforierten Ledersitzflächen /

Nappa-Leder mit Sitzflächen und Lenkrad in perforierter Velours-Mikrofaser

2LT LEDER VELOURS SITZGURTE AUßENFARBEN

SKY COOL GRAY



HUK + TU7

400 €

HU6 + TU7

1'400 €



Black (719, strd.)



Torch Red (3F9)



Yellow (3M9)



Orange (379)



Tension Blue (3A9)



Black (GBA)



Hypersonic Gray Metallic (GA7)



Arctic White (G8G)



Ceramic Matrix Gray Metallic (G9F)



Flare Silver Metallic (GSJ)



Accelerate Yellow Metallic (GDO)



Amplify Orange Tintcoat (GC5)



Torch Red (GKZ)



Tactical Red Tintcoat (GPH)



Caffeine Brown Metallic (G48)



Rapid Blue (GMO)



Elkhart Lake Blue Metallic (GS7)

ADRENALINE RED



HUL + TU7

400 €

HU7 + TU7

1'400 €



Black (719, strd.)



Torch Red (3F9)



Black (GBA)



Hypersonic Gray Metallic (GA7)



Arctic White (G8G)



Ceramic Matrix Gray Metallic (G9F)



Flare Silver Metallic (GSJ)



Torch Red (GKZ)

NATURAL



HTN + TU7

400 €

HTQ + TU7

1'400 €



Black (719, strd.)



Tan (3N9)



Torch Red (3F9)



Yellow (3M9)



Orange (379)



Tension Blue (3A9)



Black (GBA)



Hypersonic Gray Metallic (GA7)



Arctic White (G8G)



Ceramic Matrix Gray Metallic (G9F)



Flare Silver Metallic (GSJ)



Accelerate Yellow Metallic (GDO)



Amplify Orange Tintcoat (GC5)



Torch Red (GKZ)



Tactical Red Tintcoat (GPH)



Caffeine Brown Metallic (G48)



Rapid Blue (GMO)



Elkhart Lake Blue Metallic (GS7)

2LT INNENRÄUME

COMPETITION-SPORT-SITZE AE4

Nappa-Leder mit perforierten Ledersitzflächen /

Nappa-Leder mit Sitzflächen und Lenkrad in perforierter Velours-Mikrofaser

2LT

LEDER

VELOURS

SITZGURTE

AUßENFARBEN

JET BLACK



HTM

HTP

0 €

1'000 €



Black
(719, strd.)



Tan
(3N9)



Torch Red
(3F9)



Yellow
(3M9)



Orange
(379)



Tension Blue
(3A9)



Black (GBA)



Hypersonic
Gray Metallic
(GA7)



Arctic White
(G8G)



Ceramic
Matrix Gray
Metallic (G9F)



Flare Silver
Metallic (GSJ)



Accelerate
Yellow Metal-
lic (GDD)



Amplify
Orange Tint-
coat (GC5)



Torch Red
(GKZ)



Tactical Red
Tintcoat
(GPH)



Caffeine
Brown Metal-
lic (G48)



Rapid Blue
(GMO)



Elkhart Lake
Blue Metal-
lic (GS7)

ADRENALINE RED



HUL

HU7

0 €

1'000 €



Black
(719, strd.)



Torch Red
(3F9)



Black (GBA)



Hypersonic
Gray Metallic
(GA7)



Arctic White
(G8G)



Ceramic
Matrix Gray
Metallic (G9F)



Flare Silver
Metallic (GSJ)



Torch Red
(GKZ)

NATURAL



HTN

HTQ

0 €

1'000 €



Black
(719, strd.)



Tan
(3N9)



Torch Red
(3F9)



Yellow
(3M9)



Orange
(379)



Tension Blue
(3A9)



Black (GBA)



Hypersonic
Gray Metallic
(GA7)



Arctic White
(G8G)



Ceramic
Matrix Gray
Metallic (G9F)



Flare Silver
Metallic (GSJ)



Accelerate
Yellow Metal-
lic (GDD)



Amplify
Orange Tint-
coat (GC5)



Torch Red
(GKZ)



Tactical Red
Tintcoat
(GPH)



Caffeine
Brown Metal-
lic (G48)



Rapid Blue
(GMO)



Elkhart Lake
Blue Metal-
lic (GS7)

• Serienmäßig ○ Verfügbar – Nicht verfügbar

3LT INNENRÄUME

GT2-SITZE AH2

Nappa-Leder mit perforierten Ledersitzflächen /

Nappa-Leder mit Sitzflächen und Lenkrad in perforierter Velours-Mikrofaser

3LT

LEDER

VELOURS

SITZGURTE

AUßENFARBEN

JET BLACK



HTE

HTT

0 €

1'000 €



Black
(719, strd.)

Tan
(3N9)

Torch Red
(3F9)



Yellow
(3M9)

Orange
(379)

Tension Blue
(3A9)



Black (GBA)

Hypersonic Gray Metallic (GA7)

Arctic White (G8G)

Ceramic Matrix Gray Metallic (G9F)

Flare Silver Metallic (GSJ)

Accelerate Yellow Metallic (GDD)



Amplify Orange Tintcoat (GC5)

Torch Red (GKZ)

Tactical Red Tintcoat (GPH)

Caffeine Brown Metallic (G48)

Rapid Blue (GMO)

Elkhart Lake Blue Metallic (GS7)

SKY COOL GRAY



HU1

HU9

0 €

1'000 €



Black
(719, strd.)

Torch Red
(3F9)



Yellow
(3M9)

Orange
(379)

Tension Blue
(3A9)



Black (GBA)

Hypersonic Gray Metallic (GA7)

Arctic White (G8G)

Ceramic Matrix Gray Metallic (G9F)

Flare Silver Metallic (GSJ)

Accelerate Yellow Metallic (GDD)



Amplify Orange Tintcoat (GC5)

Torch Red (GKZ)

Tactical Red Tintcoat (GPH)

Caffeine Brown Metallic (G48)

Rapid Blue (GMO)

Elkhart Lake Blue Metallic (GS7)

ADRENALINE RED



HU2

-

0 €



Black
(719, strd.)

Torch Red
(3F9)



Black (GBA)

Hypersonic Gray Metallic (GA7)

Arctic White (G8G)

Ceramic Matrix Gray Metallic (G9F)

Flare Silver Metallic (GSJ)



Torch Red (GKZ)

NATURAL



HUE

HTG

0 €

1'000 €



Black
(719, strd.)

Tan
(3N9)

Torch Red
(3F9)



Yellow
(3M9)

Orange
(379)

Tension Blue
(3A9)



Black (GBA)

Hypersonic Gray Metallic (GA7)

Arctic White (G8G)

Ceramic Matrix Gray Metallic (G9F)

Flare Silver Metallic (GSJ)

Accelerate Yellow Metallic (GDD)



Amplify Orange Tintcoat (GC5)

Torch Red (GKZ)

Tactical Red Tintcoat (GPH)

Caffeine Brown Metallic (G48)

Rapid Blue (GMO)

Elkhart Lake Blue Metallic (GS7)

3LT INNENRÄUME

GT2-SITZE AH2

Nappa-Leder mit perforierten Ledersitzflächen /
Nappa-Leder mit Sitzflächen und Lenkrad in perforierter Velours-Mikrofaser

NATURAL DIPPED ²³











3LT LEDER VELOURS SITZGURTE AUßENFARBEN

LEDER	VELOURS	SITZGURTE			AUßENFARBEN					
HZN	HUF	 Black (719)	 Tan (3N9, strd.)	 Torch Red (3F9)	 Black (GBA)	 Hypersonic Gray Metallic (GA7)	 Arctic White (G8G)	 Ceramic Matrix Gray Metallic (G9F)	 Flare Silver Metallic (GSJ)	 Accelerate Yellow Metallic (GDO)
0 €	1'000 €	 Yellow (3M9)	 Orange (379)	 Tension Blue (3A9)	 Amplify Orange Tintcoat (GC5)	 Torch Red (GKZ)	 Tactical Red Tintcoat (GPH)	 Caffeine Brown Metallic (G48)	 Rapid Blue (GM0)	 Elkhart Lake Blue Metallic (GS7)





MORELLO RED DIPPED ²⁴



LEDER	VELOURS	SITZGURTE			AUßENFARBEN					
HU3	-	 Black (719, strd.)	 Torch Red (3F9)		 Black (GBA)	 Hypersonic Gray Metallic (GA7)	 Arctic White (G8G)	 Ceramic Matrix Gray Metallic (G9F)	 Flare Silver Metallic (GSJ)	
0 €								 Caffeine Brown Metallic (G48)		

TENSION/TWILIGHT BLUE DIPPED ²⁵



LEDER	VELOURS	SITZGURTE			AUßENFARBEN					
HTO	-	 Black (719)			 Black (GBA)	 Hypersonic Gray Metallic (GA7)	 Arctic White (G8G)	 Ceramic Matrix Gray Metallic (G9F)	 Flare Silver Metallic (GSJ)	
0 €			 Tension Blue (3A9, strd.)						 Rapid Blue (GM0)	 Elkhart Lake Blue Metallic (GS7)

²³ Vollfarbiges Interieur: Armaturenbrett, Türen, Teppich und Sicherheitsgurte in Natural. Konsole und Türverkleidung in Mikrofaser-Velours.

²⁴ Vollfarbiges Interieur: Armaturenbrett, Türen, Teppich und Sicherheitsgurte in Morello Red. Konsole und Türverkleidung in Mikrofaser-Velours.

²⁵ Vollfarbiges Interieur: Armaturenbrett, Türen und Teppich in Tension/Twilight Blue, Sicherheitsgurte in Tension Blue.

• Serienmäßig ○ Verfügbar – Nicht verfügbar

3LT INNENRÄUME

GT2-SITZE AH2+TU7 (ZWEIFARBIG)

Nappa-Leder mit perforierten Ledersitzflächen /

Nappa-Leder mit Sitzflächen und Lenkrad in perforierter Velours-Mikrofaser

SKY COOL GRAY



HU1 + TU7

400 €

HU9 + TU7

1'400 €



Black
(719, strd.)



Torch Red
(3F9)



Yellow
(3M9)



Orange
(379)



Tension Blue
(3A9)



Black (GBA)



Hypersonic
Gray Metallic
(GA7)



Arctic White
(G8G)



Ceramic
Matrix Gray
Metallic(G9F)



Flare Silver
Metallic (GSJ)



Accelerate
Yellow Metal-
lic (GDO)



Amplify
Orange Tint-
coat (GC5)



Torch Red
(GKZ)



Tactical Red
Tintcoat
(GPH)



Caffeine
Brown Metal-
lic (G48)



Rapid Blue
(GMO)



Elkhart Lake
Blue Metallic
(GS7)

ADRENALINE RED



HU2 + TU7

400 €

HUA + TU7

1'400 €



Black
(719, strd.)



Torch Red
(3F9)



Black (GBA)



Hypersonic
Gray Metallic
(GA7)



Arctic White
(G8G)



Ceramic
Matrix Gray
Metallic(G9F)



Flare Silver
Metallic (GSJ)



Torch Red
(GKZ)

NATURAL



HUE + TU7

400 €

HTG + TU7

1'400 €



Black
(719, strd.)



Tan
(3N9)



Torch Red
(3F9)



Yellow
(3M9)



Orange
(379)



Tension Blue
(3A9)



Black (GBA)



Hypersonic
Gray Metallic
(GA7)



Arctic White
(G8G)



Ceramic
Matrix Gray
Metallic(G9F)



Flare Silver
Metallic (GSJ)



Accelerate
Yellow Metal-
lic (GDO)



Amplify
Orange Tint-
coat (GC5)



Torch Red
(GKZ)



Tactical Red
Tintcoat
(GPH)



Caffeine
Brown Metal-
lic (G48)



Rapid Blue
(GMO)



Elkhart Lake
Blue Metallic
(GS7)

3LT INNENRÄUME

COMPETITION-SPORT-SITZE AE4

Nappa-Leder mit perforierten Ledersitzflächen /
Nappa-Leder mit Sitzflächen und Lenkrad in perforierter Velours-Mikrofaser

3LT LEDER VELOURS SITZGURTE AUßENFARBEN

JET BLACK



LEDER	VELOURS	SITZGURTE			AUßENFARBEN					
HTE	HTT	Black (719, strd.)	Tan (3N9)	Torch Red (3F9)	Black (GBA)	Hypersonic Gray Metallic (GA7)	Arctic White (G8G)	Ceramic Matrix Gray Metallic (G9F)	Flare Silver Metallic (GSJ)	Accelerate Yellow Metallic (GDO)
0 €	1'000 €	Yellow (3M9)	Orange (379)	Tension Blue (3A9)	Amplify Orange Tintcoat (GC5)	Torch Red (GKZ)	Tactical Red Tintcoat (GPH)	Caffeine Brown Metallic (G48)	Rapid Blue (GMO)	Elkhart Lake Blue Metallic (GS7)

ADRENALINE RED



LEDER	VELOURS	SITZGURTE			AUßENFARBEN					
HU2	HUA	Black (719, strd.)	Torch Red (3F9)		Black (GBA)	Hypersonic Gray Metallic (GA7)	Arctic White (G8G)	Ceramic Matrix Gray Metallic (G9F)	Flare Silver Metallic (GSJ)	
0 €	1'000 €					Torch Red (GKZ)				

NATURAL



LEDER	VELOURS	SITZGURTE			AUßENFARBEN					
HUE	HTG	Black (719, strd.)	Tan (3N9)	Torch Red (3F9)	Black (GBA)	Hypersonic Gray Metallic (GA7)	Arctic White (G8G)	Ceramic Matrix Gray Metallic (G9F)	Flare Silver Metallic (GSJ)	Accelerate Yellow Metallic (GDO)
0 €	1'000 €	Yellow (3M9)	Orange (379)	Tension Blue (3A9)	Amplify Orange Tintcoat (GC5)	Torch Red (GKZ)	Tactical Red Tintcoat (GPH)	Caffeine Brown Metallic (G48)	Rapid Blue (GMO)	Elkhart Lake Blue Metallic (GS7)

NATURAL DIPPED²⁶



LEDER	VELOURS	SITZGURTE			AUßENFARBEN					
HZN	HUF	Black (719)	Tan (3N9, strd.)	Torch Red (3F9)	Black (GBA)	Hypersonic Gray Metallic (GA7)	Arctic White (G8G)	Ceramic Matrix Gray Metallic (G9F)	Flare Silver Metallic (GSJ)	Accelerate Yellow Metallic (GDO)
0 €	1'000 €	Yellow (3M9)	Orange (379)	Tension Blue (3A9)	Amplify Orange Tintcoat (GC5)	Torch Red (GKZ)	Tactical Red Tintcoat (GPH)	Caffeine Brown Metallic (G48)	Rapid Blue (GMO)	Elkhart Lake Blue Metallic (GS7)

²⁶ Vollfarbiges Interieur: Armaturenbrett, Türen, Teppich und Sicherheitsgurte in Natural. Konsole und Türverkleidung in Mikrofaser-Velours.

• Serienmäßig ○ Verfügbar – Nicht verfügbar

3LT INNENRÄUME

COMPETITION-SPORT-SITZE AE4

Nappa-Leder mit perforierten Ledersitzflächen /
Nappa-Leder mit Sitzflächen und Lenkrad in perforierter Velours-Mikrofaser

MORELLO RED DIPPED ²⁷



3LT LEDER VELOURS SITZGURTE AUßENFARBEN

HU3

0 €



Black
(719, strd.)



Torch Red
(3F9)



Black (GBA)



Hypersonic
Gray Metallic
(GA7)



Arctic White
(G8G)



Ceramic
Matrix Gray
Metallic(G9F)



Flare Silver
Metallic (GSJ)



Tactical Red
Tintcoat
(GPH)

TENSION/TWILIGHT BLUE DIPPED ²⁸



HTO

0 €



Black
(719)



Black (GBA)



Hypersonic
Gray Metallic
(GA7)



Arctic White
(G8G)



Ceramic
Matrix Gray
Metallic(G9F)



Flare Silver
Metallic (GSJ)



Tension Blue
(3A9, strd.)



Rapid Blue
(GM0)



Elkhart Lake
Blue Metallic
(GS7)

²⁷ Vollfarbiges Interieur: Armaturenbrett, Türen, Teppich und Sicherheitsgurte in Morello Red. Konsole und Türverkleidung in Mikrofaser-Velours.

²⁸ Vollfarbiges Interieur: Armaturenbrett, Türen und Teppich in Tension/Twilight Blue, Sicherheitsgurte in Tension Blue.

- Serienmäßig ○ Verfügbar – Nicht verfügbar

REIFEN-PRODUKTDATENBLATT

VERORDNUNG (EU) 2020/740

SOMMERREIFEN 245/35 ZR19

Name des Lieferanten oder Marke	MICHELIN
Handelsname oder Handelsbezeichnung	PILOT SPORT 4 S
Reifentypkennung	343084
Bezeichnung der Reifengröße	245/35ZR19
Tragfähigkeitskennzahl	89
Symbol der Geschwindigkeitskategorie	(Y)
Kraftstoffeffizienzklasse	D
Nasshaftungsklasse	C
Klasse des externen Rollgeräuschs	B
Wert in Dezibel des externen Rollgeräuschs	70
Reifen für die Nutzung bei extremen Schneeverhältnissen geeignet	Nein
Eisreifen	Nein
Herstellungsbeginn	21/14
Herstellungsende	-
Load version	SL
Zusätzliche Information	245/35 ZR19 (89Y) TL PILOT SPORT 4 S ZP MI

REIFEN-PRODUKTDATENBLATT

VERORDNUNG (EU) 2020/740

SOMMERREIFEN 305/30 ZR20

Name des Lieferanten oder Marke	MICHELIN
Handelsname oder Handelsbezeichnung	PILOT SPORT 4 S
Reifentypkennung	633769
Bezeichnung der Reifengröße	305/30ZR20
Tragfähigkeitskennzahl	99
Symbol der Geschwindigkeitskategorie	(Y)
Kraftstoffeffizienzklasse	D
Nasshaftungsklasse	D
Klasse des externen Rollgeräuschs	B
Wert in Dezibel des externen Rollgeräuschs	73
Reifen für die Nutzung bei extremen Schneeverhältnissen geeignet	Nein
Eisreifen	Nein
Herstellungsbeginn	21/14
Herstellungsende	-
Load version	SL
Zusätzliche Information	305/30 ZR20 (99Y) TL PILOT SPORT 4 S ZP MI



MICHELIN 343084

245/35ZR19 (89Y) C1

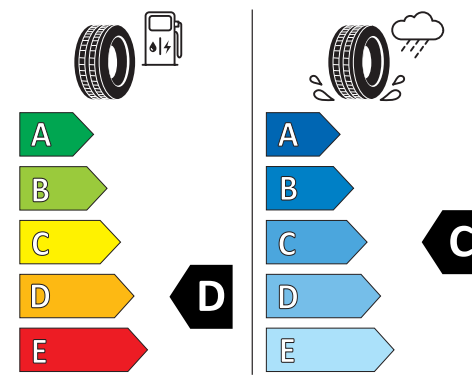

2020/740



MICHELIN 633769

305/30ZR20 (99Y) C1

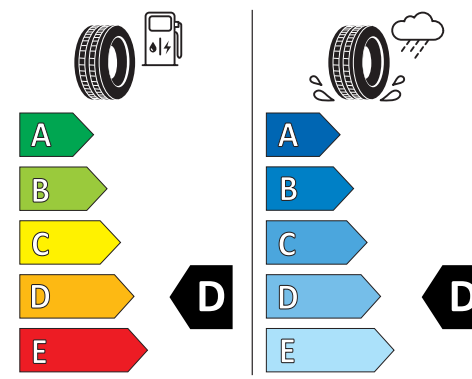

2020/740



Masse in fahrbereitem Zustand	1730–1740 kg	1767–1775 kg
Länge	4634 mm	4634 mm
Breite	1934 mm	1934 mm
Höhe	1235 mm	1234 mm
Radstand	2722 mm	2722 mm
Spurweite vorn/hinten	1647 / 1590 mm	1647 / 1590 mm

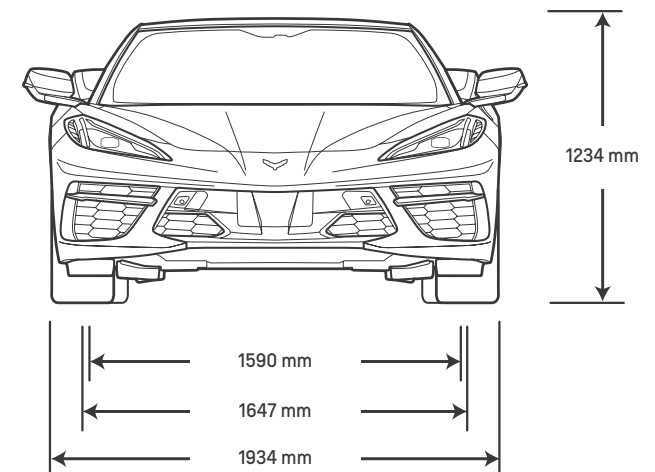
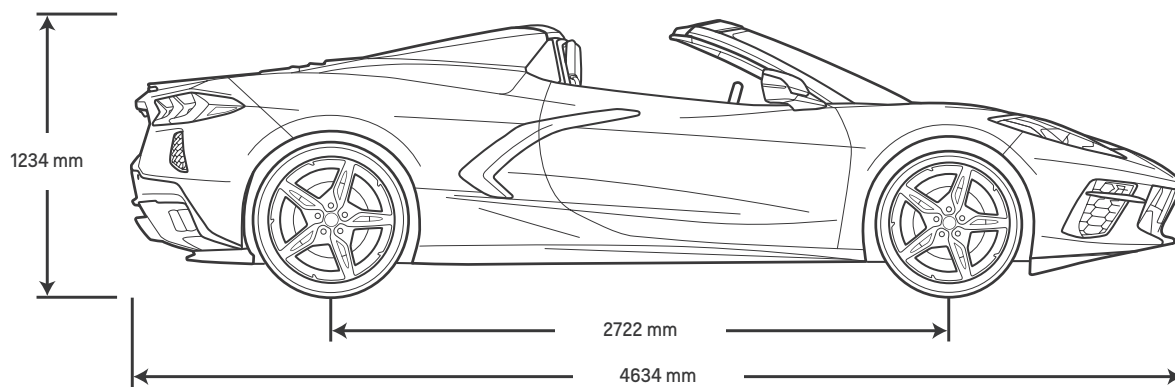
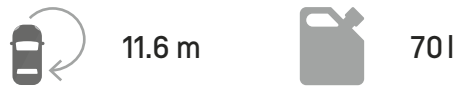
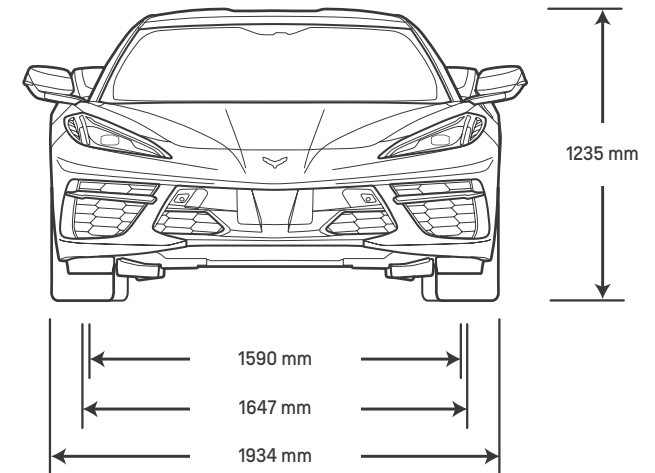
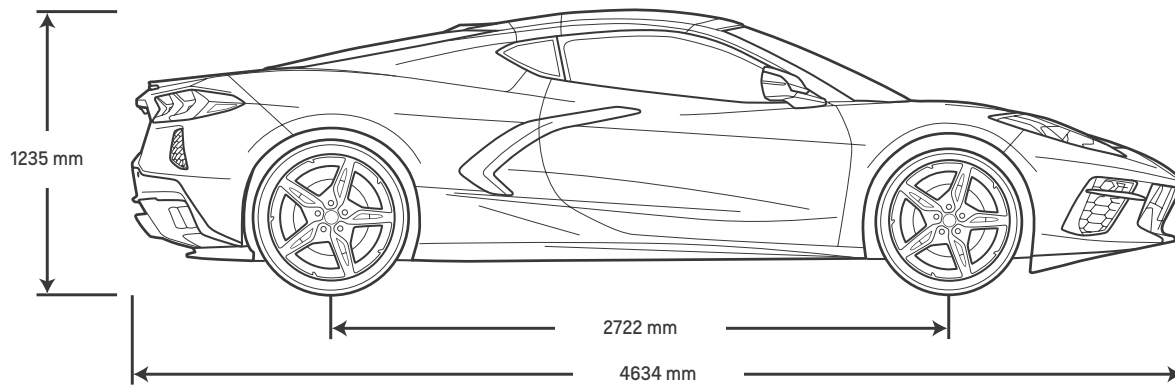

Abbildungen zeigen US-Konfiguration, die von der europäischen Version abweichen kann.
²⁹ Massen und Abmessungen gemessen gemäß der aktuellen Fassung der Verordnung (EU) Nr. 1230/2012.



CHEVROLET SERVICE

Egal, ob Sie gerade zu Hause oder auf der Straße sind – Ihre Chevrolet Vertriebs- und Service-Spezialisten stehen Ihnen rund um die Uhr mit individuellem Service zur Verfügung. Vereinbaren Sie einen Servicetermin, stellen Sie Fragen zu Ihrem neuen Chevrolet und genießen Sie das Gefühl, sich auch beim Service für ein perfektes Automobil entschieden zu haben. Einen Chevrolet Vertriebs- und Service-Spezialisten in Ihrer Nähe finden Sie im Internet unter: www.chevrolet-europe.com.



GARANTIE

Jeder Chevrolet wird mit maximaler Sorgfalt produziert und erfüllt die höchsten Standards und Normen. Wer einen Chevrolet fährt, verdient perfekten Premium-Service und -Schutz. Deshalb bietet Ihnen Chevrolet eine beschränkte Garantie von drei Jahren oder 100 000 km (je nachdem, welcher Fall zuerst eintritt) sowie eine 6-jährige Garantie gegen Durchrostung. Im Falle eines Falles kümmert sich ein erfahrenes Service-Team um Ihren Chevrolet, das jede Aufgabe kompetent und mit Sorgfalt behandelt. Bei einem Verkauf innerhalb des Garantiezeitraums wird die Garantie automatisch auf den neuen Eigentümer übertragen.



CHEVROLET MOBILITÄTSGARANTIE

Wie perfekt Ihr Chevrolet funktioniert, merken Sie auch dann, wenn er einmal nicht funktioniert. Rufen Sie einfach an, und Ihr Vertriebs- und Servicepartner steht Ihnen rund um die Uhr und an 365 Tagen im Jahr zur Verfügung. Sollte unser Mobilitätsservice Ihren Chevrolet einmal nicht vor Ort fahrtauglich machen können, bringt er Sie direkt zum nächsten Chevrolet-Partner. Die Chevrolet-Pannenhilfe steht Ihnen ab dem Datum der Erstzulassung für einen Zeitraum von 36 Monaten kostenlos zur Verfügung. Fragen Sie Ihren Chevrolet Vertriebs- und Service-Spezialisten nach weiteren Details.

BITTE BEACHTEN:

Die Informationen in diesem Prospekt entsprechen dem Stand bei Drucklegung (Januar 2022). Verfügbarkeit, technische Daten und Ausstattungsmerkmale können sich länderspezifisch unterscheiden und ohne vorherige Ankündigung geändert werden. Die in diesem Prospekt abgebildeten Fahrzeuge dienen ausschließlich zu Illustrationszwecken. Die europäischen Fahrzeugspezifikationen können sich von denjenigen im Prospekt unterscheiden. Einige Abbildungen zeigen Ausstattungselemente, die nicht in jedem Modell enthalten sind. Druckfarben geben den wirklichen Farbton nur annähernd wieder. Bei allen Spezifikationen, Abmessungen, Maßen, Bewertungen und andere Zahlen, die in diesem Prospekt oder anderen Druckmaterialien enthalten sind, die beim Autohändler bereitgestellt oder am Auto angebracht sind, handelt es sich um Schätzungen anhand der Konstruktionszeichnungen, technischen Zeichnungen, Prototypen und Labortests. Aufgrund von Abweichungen in der Herstellung und Ausstattung kann Ihr Fahrzeug andere Werte aufweisen.

Bitte informieren Sie sich über die genaue Ausstattung unserer Fahrzeuge bei Ihrem lokalen Chevrolet-Partner. Diese Unterlagen dürfen ohne die ausdrückliche schriftliche Genehmigung von General Motors weder als Ganzes noch in Teilen nachgedruckt werden. Wir behalten uns das Recht vor, jederzeit und ohne vorherige Ankündigung Änderungen an Preisen, Farben, Materialien, Ausstattung, Spezifikationen, Modellen und Verfügbarkeit vorzunehmen.



JANUAR 2022 (DE)

www.chevrolet.de